

# Datenblatt / Datasheet

## X-SUPPORT XS

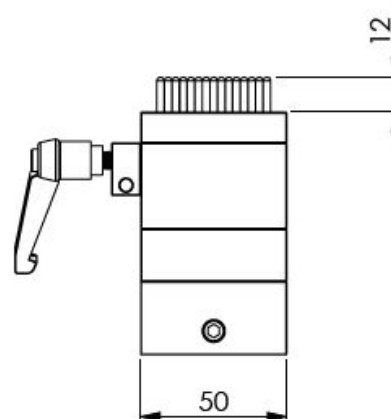
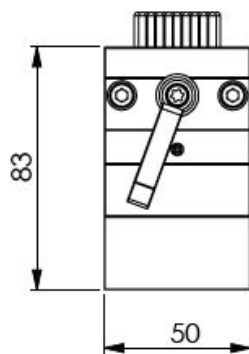
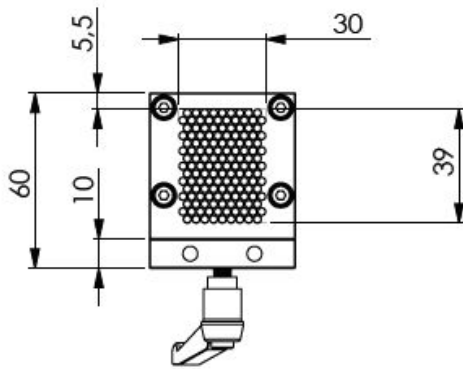

Bezeichnung / Description	X-SUPPORT XS
Bestellnummer / Order-No.	0050.1423
Außenabmaße / Dimension B x L x H [mm]	50 x 50 x 83
Spannfläche / Dim. Pin-field BS x LS [mm]	30 x 39
Anzahl Stößel / Number of pins	142
Durchmesser Stößel / Pin Ø D [mm]	2,4
Hub / Pin stroke HB [mm]	12
Gewicht / Weight	0,66 kg
Spannschraube / Clamping screw	M6 Handhebel / Lever
Pneumatischer Anschluss (Reinigung) / Pneumatic connector (for cleaning)	M5
Einbaulage / Mounting position	beliebig / any
Zubehör / Accessories	Set
CAD-Daten / CAD-Data	STEP

MATRIX GmbH  
 Spannsysteme & Produktionsautomatisierung  
 Felix-Wankel-Str. 6  
 73760 Ostfildern  
 GERMANY

Phone: +49 (0) 711 / 22 93 28-0  
 Fax: +49 (0) 711 / 22 93 28-22  
 eMail: info@matrix-innovations.com