

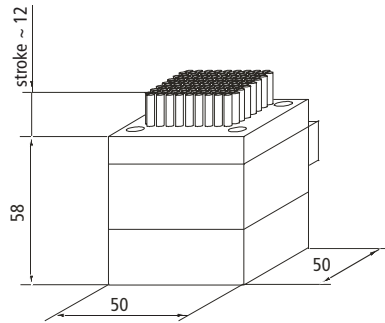

The MATRIX-System
Form Adapting Support Technique

X-Support XS
pin diameter 2.5 mm
incl. 1 case
OrderNo. 0050.1424



0050.1423

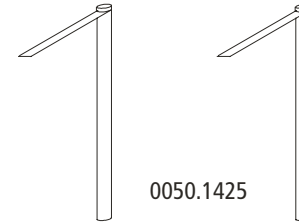
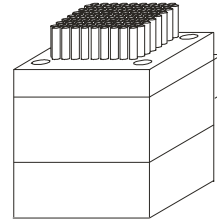

0050.1425

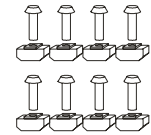

0900.2501

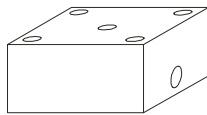

0050.3126

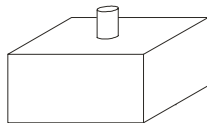
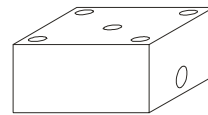

0050.3127

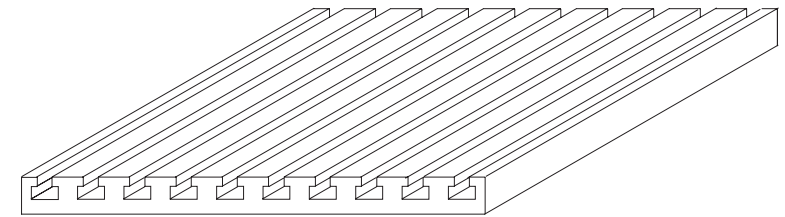
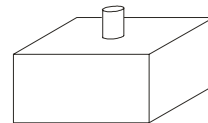

0900.0500 (250mmx200mm)

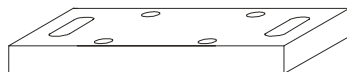

0050.3128

