

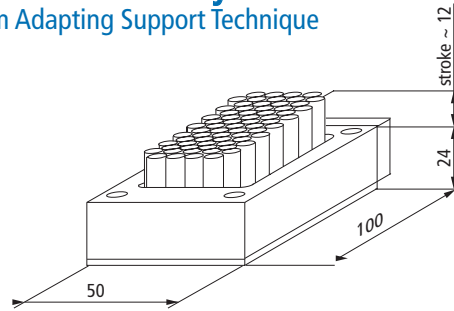

The MATRIX-System
Form Adapting Support Technique

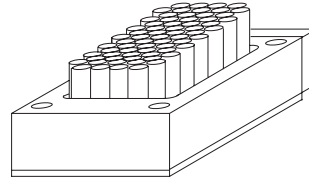

0050.6711



0050.6711

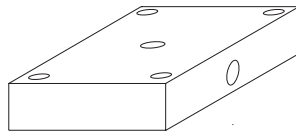

0050.6706

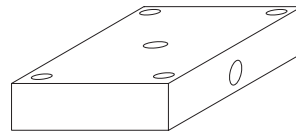

0050.6706

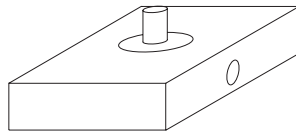

0050.6715

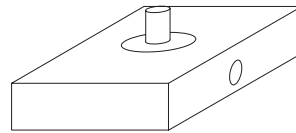

0050.6715

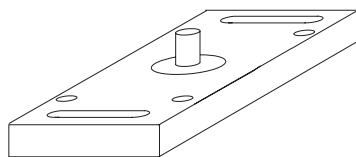

0050.6712

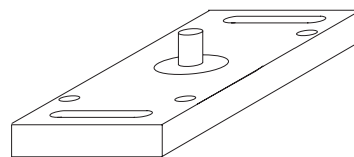

0050.6712

X-Support F
pin diameter 6.0 mm
incl. 1 case
OrderNo. 0050.6713

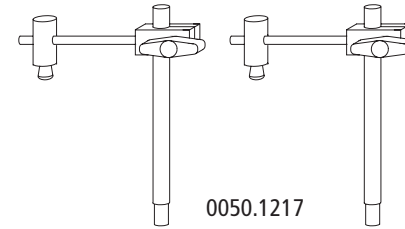

0050.1217

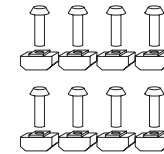

0900.2501

