

Bestell-Nummer/Order-Number: 0050.5815

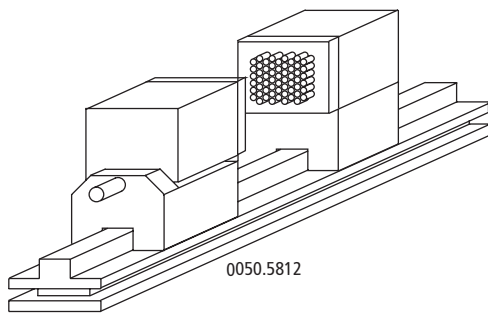

1 St/pc. 0050.5812

X-Grip XS Modul

Grundfläche/base: 38 x 250 mm
Anzahl der Stößel/number of pins: 58 Stück/pieces*
Stößel-Durchmesser/pin diameter: 2,5 mm
Stößel-Hub/pin stroke: 12 mm

*pro Backen/per jaw

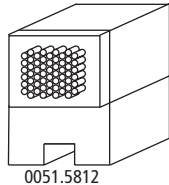

1 St/pc. 0051.5812

Fester Backen X-Grip XS/

Fixed jaw X-Grip XS
Anzahl der Stößel/number of pins: 58 Stück/pieces
Stößel-Durchmesser/pin diameter: 2,5 mm
Stößel-Hub/pin stroke: 12 mm

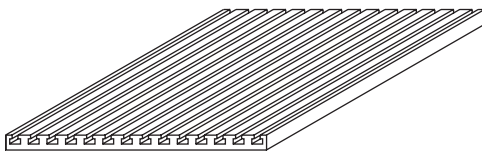

1 St/pc. 0900.0500

T-Nuten Profilplatte/
T-slotted profil plate
Grundfläche/base size: 375 x 500 mm
Nutbreite/slot width: 8 mm

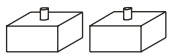

0050.3127
Anschlusselement
Connection module
25 x 50 x 50 mm

2 Stück/pieces

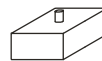

0050.6727
Anschlusselement
Connection module
25 x 50 x 100 mm

1 Stück/piece



0050.3128
Grundplatte
Base plate
10 x 50 x 100 mm

2 Stück/pieces

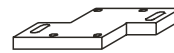

0050.6728
Grundplatte
Base plate
10 x 100 x 100 mm

1 Stück/piece

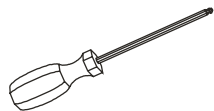

0900.0000
Schraubendreher
Screwdriver

1 Stück/piece

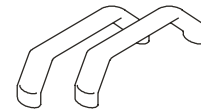

0900.3620
Bügelgriffe
Handles

2 Stück/pieces

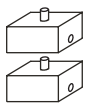

0050.3125
Zwischenelement
Intermediate module
25 x 50 x 50 mm

2 Stück/pieces

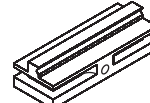

0050.5867
Führungsschiene bewegl.
Backen/straight guide bar
for moveble jaw 100 mm

1 Stück/piece

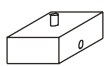

0050.6725
Zwischenelement
Intermediate module
25 x 50 x 100 mm

1 Stück/piece



0050.5831
Führungsschiene fester
Backen/straight guide bar
for fixed jaw 50 mm

2 Stück/pieces

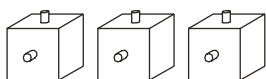

0050.3150
Gelenkelement
Intermediate module
50 x 50 x 50 mm

3 Stück/pieces

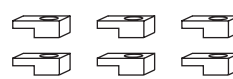

0900.0506
Spannpratzen
Mounting kit
6 St/6 pcs. (0900.0502)

1 Set



0050.5825
Zwischenelement
Intermediate module
25 x 50 x 50 mm
(1 Stück/pieces)

1 Set



0051.5825
Zwischenelement
Intermediate module
25 x 50 x 50 mm

1 Stück/piece

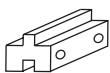

25 x 50 x 70 mm
(1 Stück/piece)



0050.1230
Winkelstück stufenlos
Ø 26 mm

1 Stück/piece

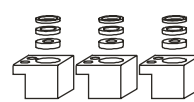

0900.0501
Spannpratzen
Mounting kit
3 St/3 pcs.

1 Set

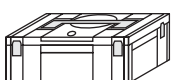

0900.9000
Koffer mit Einlagen
Case with Inlays

1 Stück/piece

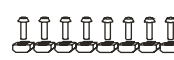

0900.2501
Befestigungs-Satz
Mounting Kit
8 St/ 8 pcs.

1 Set